

AVK CHECK VALVES



EXPECT
A LONG-TERM
PARTNERSHIP

Expect... **AVR**

SERIES 41 & SERIES 641 SWING CHECK VALVES

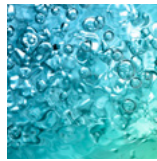
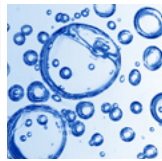
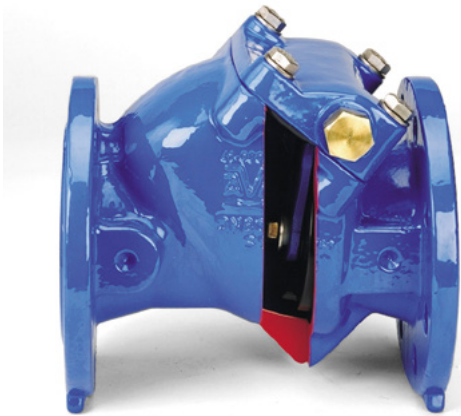

**For Water and Sewage
Applications**

AVK swing check valves are available in DN 50-1000 and feature full bore and low head loss, as well as easy access to maintenance and a great durability. The swing check valves can be installed in both horizontal and vertical positions.



Unique design

By unscrewing a few bolts the bonnet assembly including hinge and disc can be removed from the body. The hinge is tightened around the shaft with bolts to eliminate play and thus ensure durability.

Feature summary

- Full bore ensures low head loss when fully open
- Full bore prevents pressure loss allowing maximum utilization of pump capacity
- Bonnet/disc design gives easy access to maintenance
- Fully rubber coated disc prevents corrosion and ensures drip-tight closure and long life
- Light-weight disc requires a minimum of force to open and close the valve
- The disc is mounted in a nylon bushing, which allows it to move slightly both horizontally and vertically to close completely tight also in case of minor impurities in the seat
- Hinge tightened around the shaft with bolts to eliminate play and thus ensure durability
- Ductile iron epoxy coated to DIN 30677-2
- Available with or without lever and weight
- Other options available complete with limit switch





Resilient seated disc with Stainless Steel hinge.

The valve is ideal for installation in the horizontal position and used where there is an insignificant risk of water hammer. This design features a distinctly low head loss and is used in installations, where the dry matter percentage is max. 10%. Optimum sealing at not less than 0.5 bar pressure. The valve is suitable for underground installation.

Swing check valve with external lever and weight.

For installations with an insignificant risk of water hammer, but where the minimising of head loss is important. The lever is also useful as an indicator of the valve disc position. The valve is suitable for horizontal and vertical installations.

Swing check valve with external lever and weight plus limit switch.

Cam operated IP66 limit switch. Mechanical roller plunger with the ability to easily set the cam at any given position. Maintenance free and vibration resistant cage clamp terminals.

Large diameter metal seated check valve.

This valve is ideal for potable water and sewerage applications and suitable for temperatures up to 70°C.

The body, bonnet, hinge and metal seated disc are all constructed with high grade Ductile Iron to EN 1563, EN-GJS-500-7. The seat is aluminium bronze.

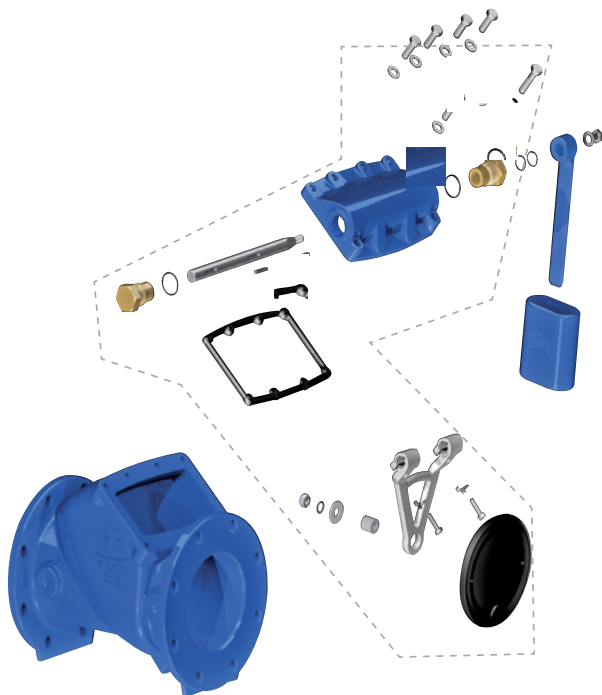

To achieve the optimum performance from any swing check valve, a velocity of 1.5 to 2m/s is required to fully open the valve, and to reduce turbulence a straight piece of pipe five (5) times



A guard covering the lever and weight eliminates the risk of injuries. Optionally with proximity switches for remote monitoring.

SERIES 641 RECOIL NON SLAM CHECK VALVES



2 Door
641/21 DN600-800

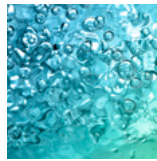
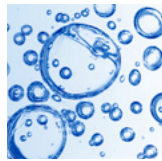
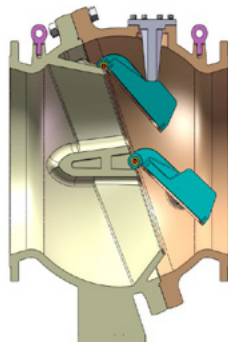

**For Water and Sewage
Applications**

The AVK single and multi door 'Recoil' high performance non-return valve has been designed after extensive practical hydraulic laboratory testing. These in-house tests have led to the development of a superior check valve that will close the instant forward flow ceases.

The 'Recoil' valve will close in under one second thus eliminating the opportunity for water hammer.

All of these design features ensure that the Series 641 Recoil Valve is superior to conventional swing check valve designs.

- Slope of the body face, and the door opening arc length.
- Weight of the door, and the manner in which the weight is distributed.
- Location of the hinge pin in relation to the plane of the faces.
- Large volume area around the door to reduce turbulence at the closure point.

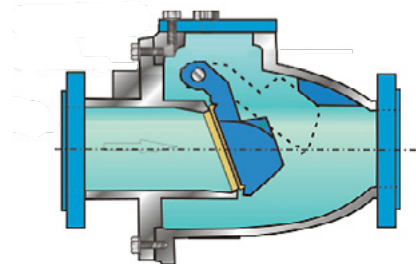

Single Disk
641/11 - DN100-500



Since a self-acting reflux valve can only close under the action of the force due to gravity, and since the inertia of the moving parts has to be overcome, the actual acceleration of the door is necessarily less than 'g'.

But the water column is in contact with the door, thus if the acceleration of the water column is greater than 'g' it is obviously impossible for the door to close more quickly than the column can reverse. It is therefore of vital importance to design a non-return valve intended to work in extreme conditions, in such a way that every mechanical and hydraulic assistance is directed towards accelerating the movement of the door.

This has been done in the Glenfield "Recoil" valve; mechanical assistance is given by a combination of inertia reduction, concentration of mass, ideal suspension of the moving elements and by localising the movement in a particular portion of the water stream. Hydraulic assistance is given by the avoidance of cavitation and by a novel provision for forward and recoil water streams within the body and around the valve door.



Features

- High Density Door
- Integral Body/Door Unit
- Frictionless Bearings
- Voluminous Body
- Selected Angular Travel
- Minimum Reverse Velocity
- Flexible Closure Time
- Metal seated valve with gunmetal body seats and gunmetal faced doors
- No additional damping required
- By-pass bosses as standard
- Epoxy coating

Benefits

- Maximum Closing Force
- Accurate Alignment
- Fast and Non slam operation
- Minimum Hydraulic Resistance
- Optimum Arc Length
- Faster closing time
- Perfect System Match

Options:

- PN25 version
- By-pass
- Limit/proximity sensors
- Alternative trim
- Larger Sizes
 - 900, 1000, 1200 with 3 Door
 - 1400, 1600 with 4 Door

SERIES 53 BALL CHECK VALVES



For Sewage Treatment Applications

AVK Ball Check Valves are available with internal thread Series 53/30 DN32-50 and with flanges Series 53/35 in DN50-600. The basic valve design ensures easy maintenance, cost effective operation and long life.



The design features 100% free flow, as the ball is completely out of the valve flow path when in the fully open position.

The straight bore prevents deposits in the valve, as all impurities can pass through the valve. Consequently the AVK ball check valves feature very low head loss giving the benefits of optimum use of pump capacity.

Great installation flexibility is another essential benefit of the unique valve design. The valve can be installed both vertically and horizontally as the valve body locates the ball against the seat in either valve position.

Based on AVK's experience within the sewage treatment sector the materials selected ensure long life and optimum function under a wide range of working conditions.

The body and bonnet are made of Ductile Iron

with electrostatically applied epoxy coating internally and externally.

Thorough control of layer thickness, adhesive strength and impact resistance of the coating is maintained to ensure optimum corrosion protection.

The bonnet bolts and nuts are made of Stainless Steel A4 providing high strength and corrosion resistance.

The standard balls are made with a solid aluminum core in DN 32-40, a hollow aluminum core in DN 50-100 and DN 500-600, and a hollow cast iron core in DN 125-400. The metal core is NBR rubber lined, and the rubber hardness is optimized to prevent the ball from getting stuck in the seat. The NBR rubber ensures optimum sealing.

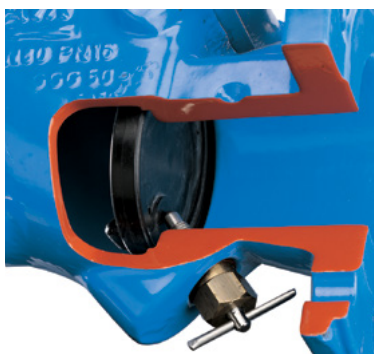

The AVK ball check valves are as standard supplied with a hollow Cast Iron or aluminium core vulcanised with an NBR liner.



Balls dedicated for the application

Balls of polyurethane are suitable for abrasive media and when different ball weights are needed to prevent noise and water hammer. NBR rubber lined balls have a metal core of aluminium or cast iron depending on the size.



Main features and benefits

- Full bore minimizes pressure loss allowing maximum utilization of pump capacity
- No accumulation of deposits due to the straight bore
- Fully rubber coated ball prevents corrosion and ensures drip tight closure at low pressures and long life
- Optimum sealing in both vertical and horizontal installation, as the valve bottom supports the ball against the seat.
- Self-cleaning due to rotating ball
- No need to remove valve body from pipeline for maintenance
- Valve length is to EN 558 table 2 series 48
- Full flow equal to nominal size
- Long life assured with the use of high quality materials
- Polyurethane balls available for abrasive media
- Different ball weights available
- Ductile iron body and bonnet with epoxy coating internally and externally
- Available with flanges in DN 50-600, internal BSP threads in DN 32-50 in ductile iron

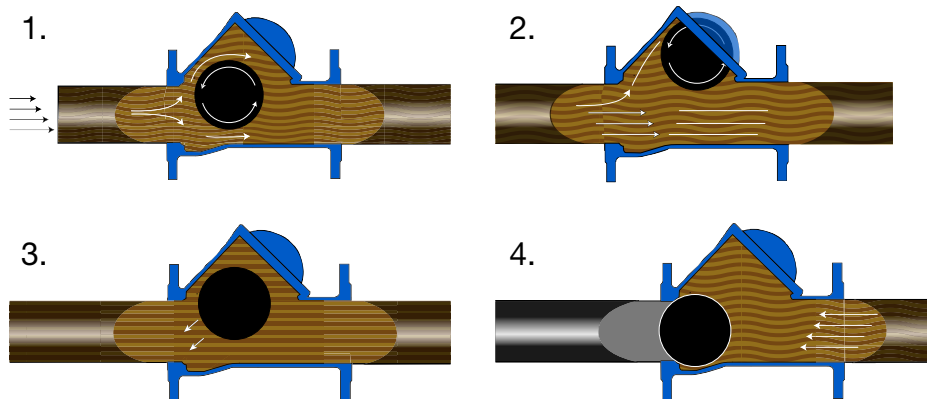

Functional description of a Ball Check Valve Series 53



A horizontal installation requires a minimum flow velocity of 1 - 1.5 m/s to open effectively. A recommended back pressure of 0.6 bar is needed when closing the valve.



The ideal placement of the ball check valve is in the vertical position.

SERIES 903 SILENT CHECK VALVES

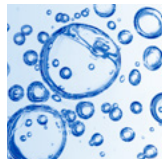
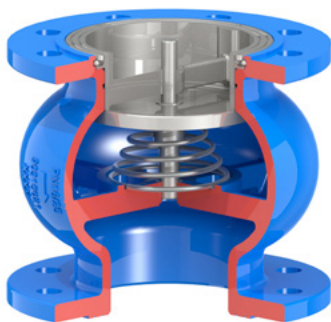

**For Water and Building
Applications**

AVK silent check valves are available in DN 65-400 and are designed to prevent back flow in high temperature range pumping applications. The valve element movement is controlled via a central guide where a centrally mounted spring together with the short movement aids the quick closing that is essential in reducing shock associated with valve closure. It can also eliminate water hammer problems connected with the use of conventional swing check valves.

Features:

- The combination of light disc, short stroke distance and fast closing spring design is effectively mitigating slamming
- Streamlined contour for low head loss
- The special seat design ensures quick and easy trim replacement
- Fusion bonded epoxy coating on both external and internal surfaces
- Metal seat for durability and high temperature tolerance
- Up to and including DN200, the design makes it possible to mount a butterfly valve at the outlet side of the silent check valve, without any additional adapters.

Standards:

- Designed according to EN 12334
- Face to face according to MSS SP-125 short globe
- Standard flange drilling to EN 1092-2 (ISO 7005-2), PN 10/16/25

Test/Approvals:

- Experimental shell design strength according to EN 12516-3
- Test according to EN 12266

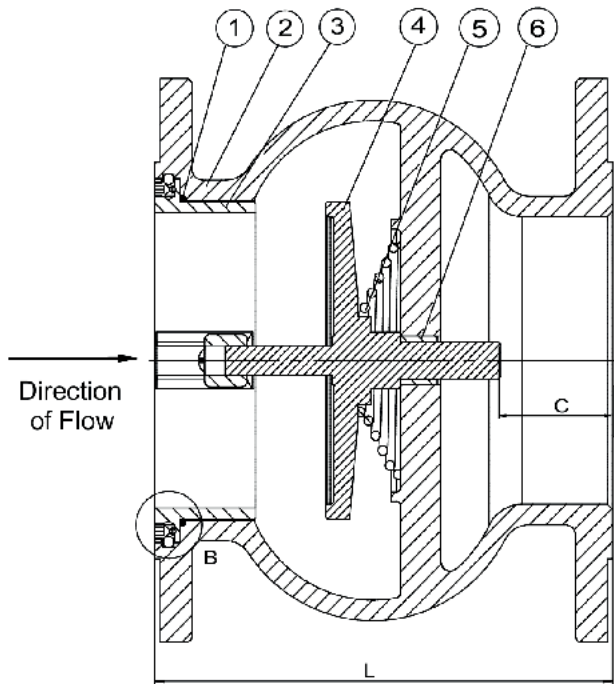

SECTION A-A
Disc shown in fully open position

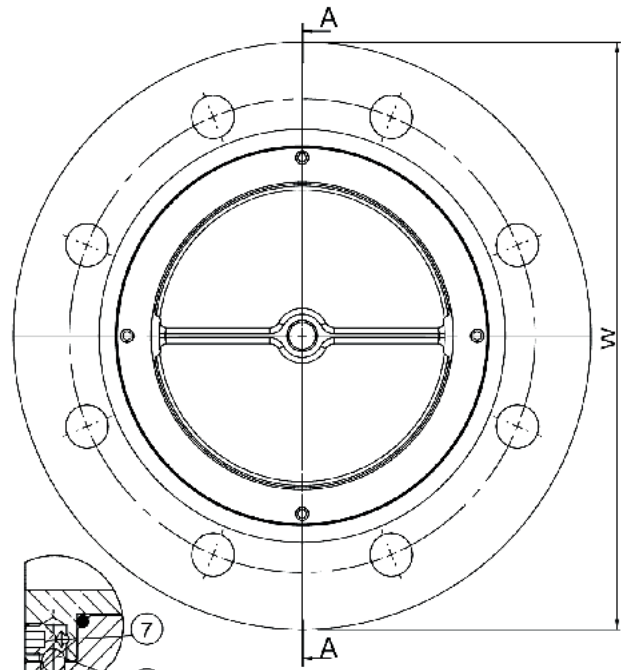

DETAIL B
SCALE 1 : 1

Component list

1.	O-ring	EPDM rubber	5.	Spring	Stainless steel 1.4301
2.	Body	Ductile iron GJS-500-7 (GGG-50)	6.	Bush	Stainless steel 316
3.	Seat	Stainless steel 1.4308	7.	Set screw	Stainless steel A2
4.	Disc	Stainless steel 1.4308	8.	Retainer ball	Stainless steel 304

AVK CHECK VALVES



Series 41/20

Double flanged
FTF to EN558 table 2
Ser.10
Swing check type
Resilient seated
Right side free shaft end
DN50-300
PN10/16
Ductile iron

Options:

- Lever&weight
- Lever protection guard
- proximity switch

Datasheets:
• 041/20-001



Series 41/21

Double flanged
FTF to EN558 table 2
Ser.10
Swing check type
Resilient seated
Enclosed shaft end
DN50-300
PN10/16
Ductile iron

Datasheets:
• 41/21-001



Series 41/22

DDouble flanged
FTF to EN558 table 2
Ser.10
Swing check type
Resilient seated
Right side lever&weight
DN50-300
PN10/16
Ductile iron

Options:

- Lever protection guard
- proximity switch

Datasheets:
• 41/22-001



Series 41/35

Double flanged
FTF to EN558 table 2
Ser.48
Swing check type
Metal seated
Enclosed shaft end
DN350-600
PN10/16
Ductile iron

Datasheets:
• 41/35-001



Series 41/36

Double flanged
FTF to EN558 table 2 Ser.48
Swing check type
Metal seated
Enclosed shaft end
DN350-600
PN10/16
Ductile iron

Options:

- Lever protection guard
- proximity switch

Datasheets:
• 41/36-001 (1.4021 stem 250my coating without guard)
• 41/36-003 (1.4404 stem 300my coating without guard)
• 41/36-004 (1.4404 stem 300my coating with guard)
• 41/36-007 (1.4021 stem 250my coating with guard)



Series 41/39

Double flanged
FTF to EN558 table 2
Ser.48
Swing check type
Metal seated
Right side lever&weight
DN350-600
PN10/16
Ductile iron

Options:

- Lever&weight
- Lever protection guard
- proximity switch

Datasheets:
• 41/39-004 (1.4021 stem 250my coating)
• 41/39-005 (1.4404 stem 300my coating)



Series 53/30

Double threaded
FTF to EN558 table 2
Ser.48
Ball check type
Resilient seated
DN32-50
PN10
Ductile iron

Datasheets:
• 53/30-005



Series 53/35

Double flanged
FTF to EN558 table 2
Ser.48
Ball check type
Resilient seated
DN50-600
PN10
Ductile iron

Datasheets:
• 53/35-003



Series 641/01

Double flanged
Swing check type
Metal seated
DN700-1000
PN10/16
Ductile iron

Options:

- Lever&weight
- Lever protection guard
- Limit/Proximity switch

Datasheets:
• 641/01-001 (Left side L&W&G with proximity switch)
• 641/01-004 (Enclosed shaft end)
• 641/01-007 (Left side fre shaft end with cover)

**Series 641/11**

Double flanged
Recoil check type
Metal seated
DN100-500
PN10/16
Ductile iron

Options:

- Limit/Proximity switch

Datasheets:

- 641/11-001 (DN350-500)
- 641/11-002 (DN100-300)

**Series 641/13**

Double flanged
Recoil check type
Metal seated
DN100-500
PN25
Ductile iron

Options:

- Limit/Proximity switch

Datasheets:

- 641/13-001 (DN350-500)
- 641/13-002 (DN100-300)

**Series 641/21**

Double flanged
Recoil check type
Metal seated
DN600-1600
PN10/16
Ductile iron

Options:

- Limit/Proximity switch

Datasheets:

- 641/21-002 (Without bypass)
- 641/21-003 (With bypass)

**Series 641/23**

Double flanged
Recoil check type
Metal seated
DN600-1200
PN25
Ductile iron

Options:

- Bypass
- Limit/Proximity switch

Datasheets:

- 641/23-002 (With bypass)
- 641/23-003 (Without bypass)

**Series 903/20**

Double flanged
Silent check type
Metal seated
DN65-400
PN10/16/25
Ductile iron

Datasheets:

- 903/20-001 (PN10/16)
- 903/20-002 (PN25)

Note: Datasheets only show part of variants. More variants are available, please contact AVK if required.



PT. AVK Fusion Indonesia

Taman Tekno Blok F1/F-CDE
BSD City, Serpong,
Tangerang Selatan,
Banten 15314

Tel.: +62-21-75682627
Fax: +62-21-75682628
<https://www.avkfusion.co.id>
customercare@avkfusion.co.id

Copyright©AVK Fusion Indonesia 2023

Expect... **AVR**